

PortKeys

BM5 WR

2200nit Anti-Fingerprint 5.5 Inch
Wide Color Gamut Screen



Contents

Product Information

Product Wireframe	1.1
Product Accessories	1.2
Product Parameters	1.3
Product Signal Specifications	1.4

Shortcut Function Interface

Shortcut Function Interface Gesture Switching	2.1
Function Use	2.2
Parameter Settings	2.3
Long press the icon to change the function or delete the function	2.4

Settings Interface

Set Interface Gesture Switching	3.1
Image Settings	3.2
System Settings	3.3
LUT Settings	3.4
Version Settings	3.5

Camera Control Interface

Camera Control Interface Gesture Switching	4.1
Camera Model Settings	4.2
Bluetooth Connection	4.3
Function Use	4.4
WIFI Connection	4.5

Motor Control Interface

Motor Control Interface Gesture Switching	5.1
Motor Control	5.2

Product Appearance Size

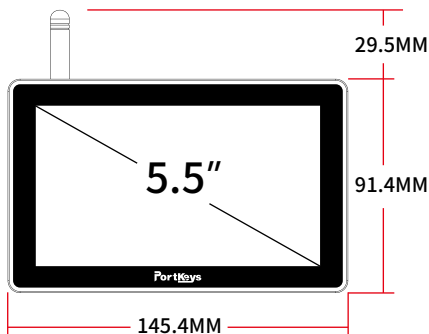

EXIT / Long press for 3 seconds
to switch the state of touch control

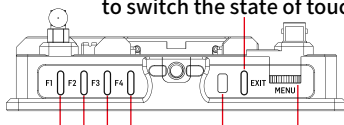

Custom Function Keys

Indicator

Sliding Menu
(Volume +/-)

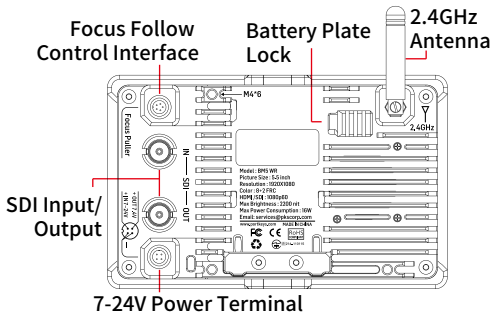

Focus Follow
Control Interface

Battery Plate
Lock

2.4GHz
Antenna

SDI Input/
Output

7-24V Power Terminal

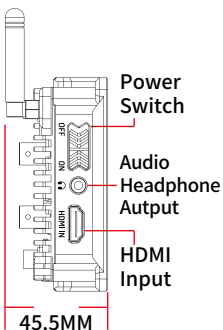

Power
Switch

Audio
Headphone
Output

HDMI
Input

45.5MM

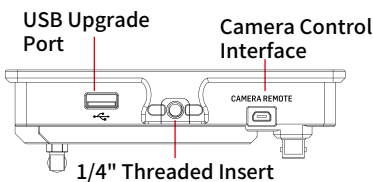

USB Upgrade
Port

Camera Control
Interface

1/4" Threaded Insert



Operating temperature range: 0 °C ~ 40 °C

Standard Accessories

BM5 WR Monitor X1

LANC Control Cable 0.4m X1

TYPE-C Control Cable 0.4m X1

Warm Prompt Card X1

Safety Box X1

L-Type Antenna X2

Power Cord 1m (Aviation

Head - D-TAP) X1

Power Cord 0.4m (Aviation

Head - DC) X1

U Disk (Manual, 3D LUTs,

Firmware Inside) X1

Parameter

Size	5.5"
Dimension	145.4x120.9x45.5mm
Viewing Angle	178°H/178°V
Brightness	2200nit
Resolution	1920x1080
Contrast Ratio	1000:1
Weight	376g
Color	10bit(8+2 FRC)
Backlight	WLED
Material	Aluminum Alloy + Toughened Glass
Input Voltage	DC 7~24V
Max Power	13W
Signal Input	3G SDI, HDMI
Signal Output	3G SDI
Headphone	Output
Menu Language	简体中文/English
Power Input / Output	4pin Aviation Connector
Signal Conversion	HDMI IN to SDI OUT
Camera Control Interface	Focus Puller / CAMERA REMOTE
Support Battery Model	SONY NP-F970/F960/F750/F550
Upgrade Firmware / Load LUT	USB-A
Fan	Yes
Antenna	2.4G

Signal specifications

Supported input resolution and frame rate

HDMI Signal

1920×1080p@23.97Hz,24Hz,25Hz,29.97Hz,30Hz,50Hz,59.94Hz,60Hz

1920×1080psf@23.97Hz,24Hz,25Hz,29.97Hz,30Hz

1920×1080i@50Hz,59.94Hz,60Hz

1280×720p@50Hz,59.94Hz,60Hz

720×576p&720×576i@50Hz

720×480p&720×480i@50Hz,59.94Hz,60Hz

Supported input/output resolution and frame rate

SDI Signal

1920×1080p@50fps,59.94fps,60fps

1920×1080p@50Hz,59.94Hz,60Hz YUV422

1920×1080p@23.98Hz,24Hz,25Hz,29.94Hz,30Hz YUV444/YUV422/RGB444

1920×1080psf@23.98Hz,24Hz,25Hz,29.97Hz,30Hz YUV444/YUV422/RGB444

1920×1080i@50Hz,59.94Hz,60Hz YUV444/YUV422/RGB444

1280×720p@50Hz,59.94Hz,60Hz YUV444/YUV422/RGB444

720×480i@59.94Hz YUV422

720×576i@50Hz YUV422

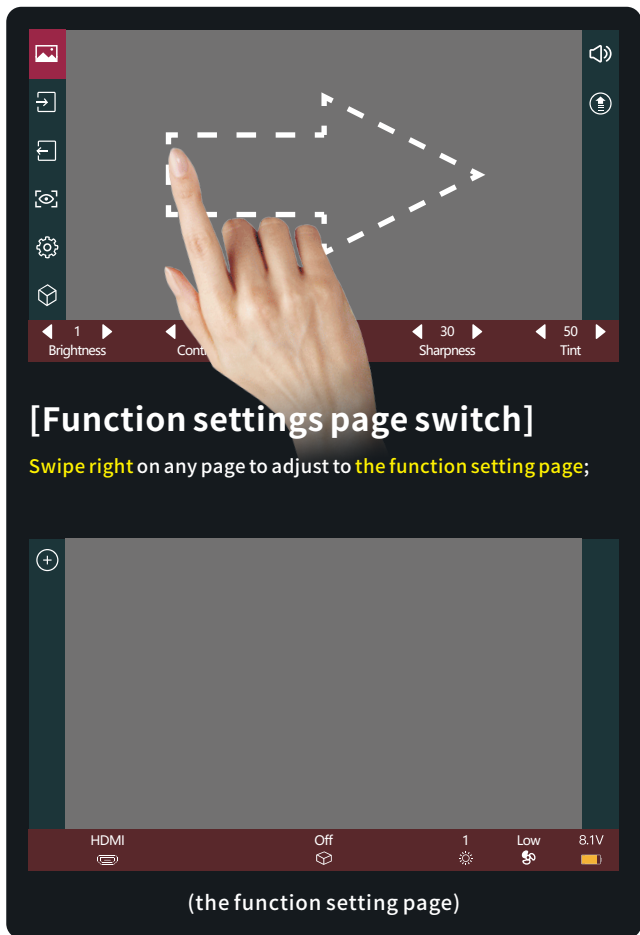

[Function settings page switch]

Swipe right on any page to adjust to the function setting page;

(the function setting page)

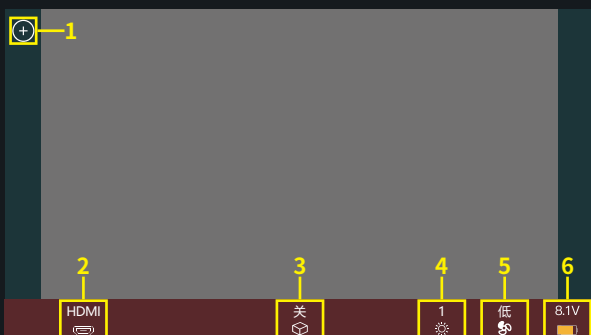

[Shortcut Function Setting]

1. Add function icon;
2. Switch HDMI/SDI signal;
3. 3D LUT ON/OFF;
4. Screen brightness (1-10);
5. Fan strength (Low /Middle/High);
6. Battery level;

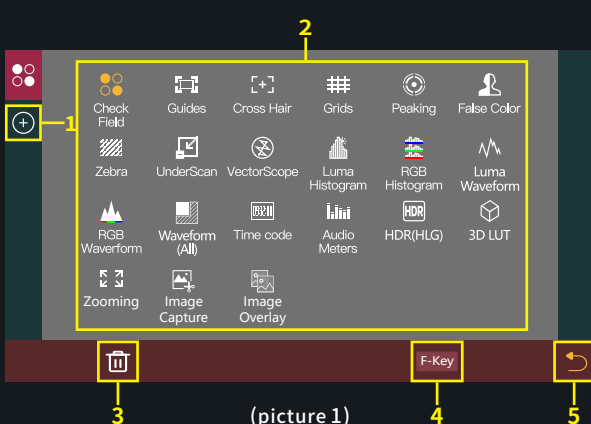

1. Click “+” add shortcut functions to the left and right sides; If the function icons on the left and right have been added (picture 2); can swipe down in the shortcut function title area to continue adding;
2. Select the function icon to replace;
3. Select the function icon and click “🗑️” to delete;
4. Click “F-Key” to enter F key Setting (picture 3);
5. “↶” Return key;

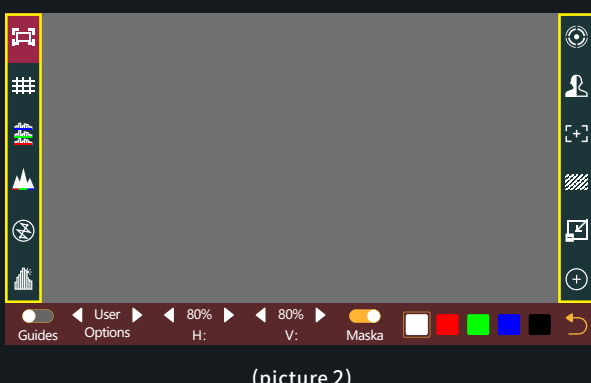

(picture 2)

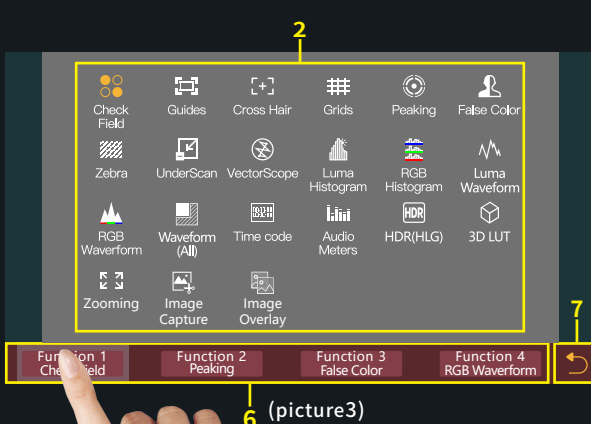

(picture 3)

6. The F key has 4 physical keys, which can be customized; Select any button in this area in the function icon "2" for custom function settings;
7. “↶” Return key;



(picture 4)

8. F key setting is completed, F1-F4 button on the monitor to turn on/off the function. (picture 4);

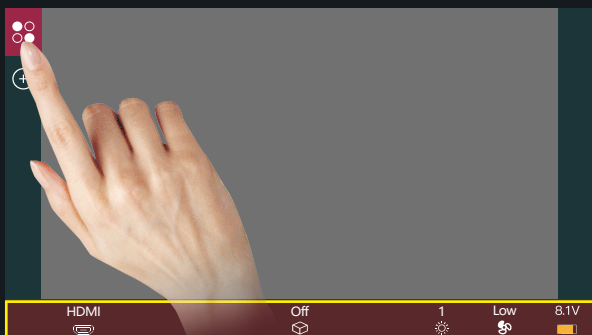

(Picture 5)

Click “”, The parameter information setting is displayed at the bottom (Picture 5);

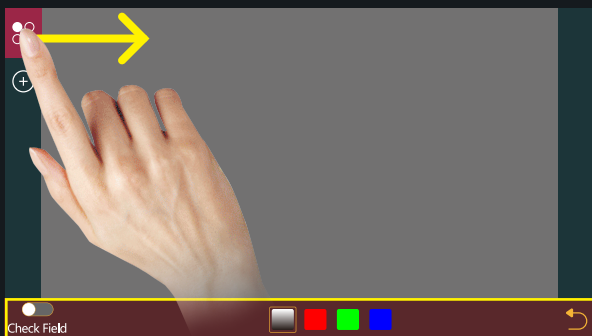

(Picture 6)

Hold “” and slide to the right, The bottom will jump to the function parameter settings; For other functions, user can repeat the above operations or directly click to set parameters (Picture 6);

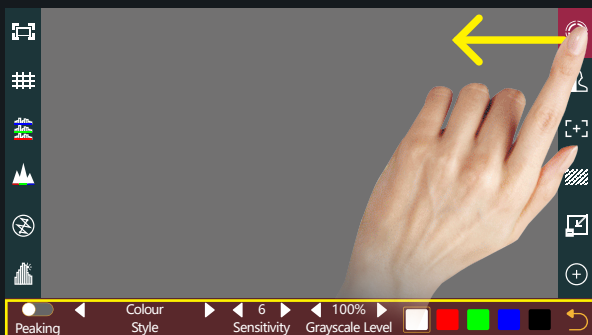

(Picture 7)

Hold “” and slide to the left, The bottom will jump to the function parameter settings; For other functions, you can repeat the above operations or directly click to set parameters (Picture 7);

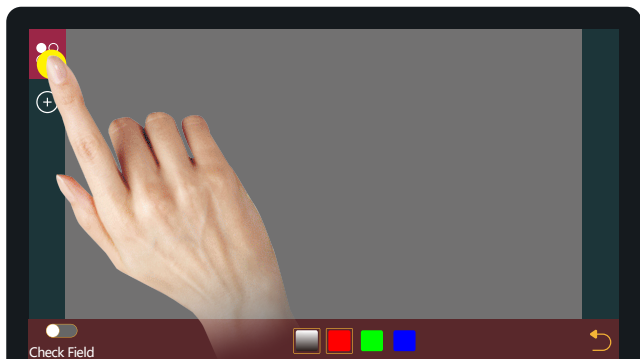

If this feature is not required ,Long press “” to jump to (picture 8) for function replacement/deletion ;

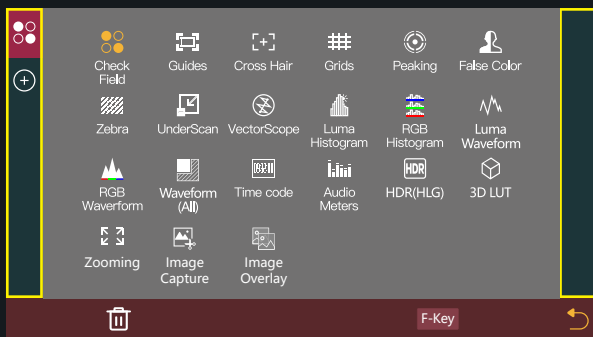

(Picture 8)

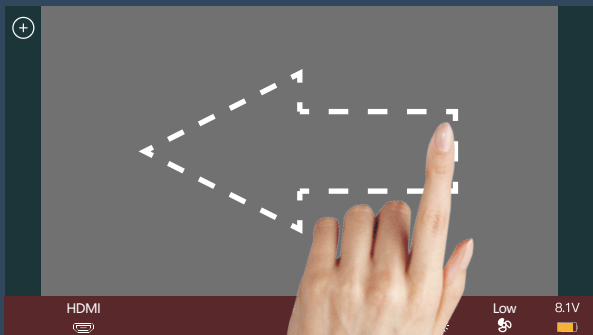

[System settings page switch]

Swipe left on any page to adjust to the system settings page;

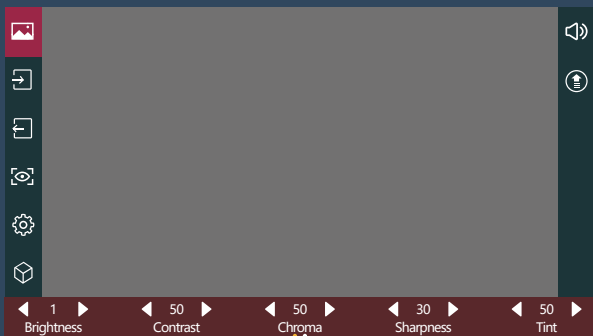

(the system settings page)

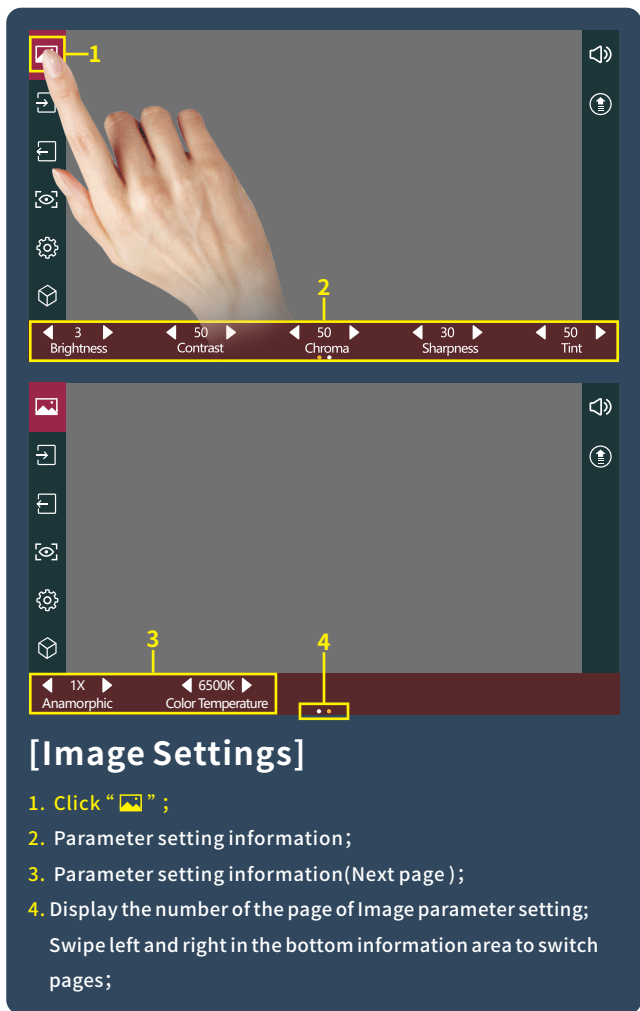

[Image Settings]

1. Click “” ;
2. Parameter setting information;
3. Parameter setting information (Next page) ;
4. Display the number of the page of Image parameter setting;
Swipe left and right in the bottom information area to switch pages;

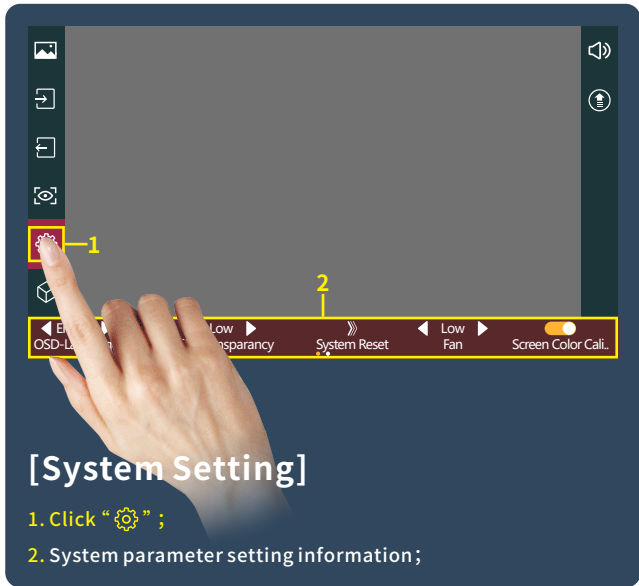

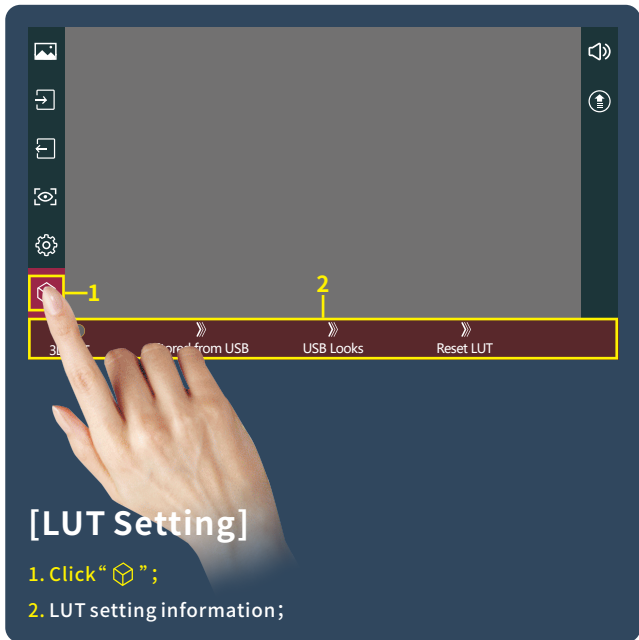

[LUT Setting]

1. Click “



[Version Setting]

1. Click “”;
2. View version information and upgrades;

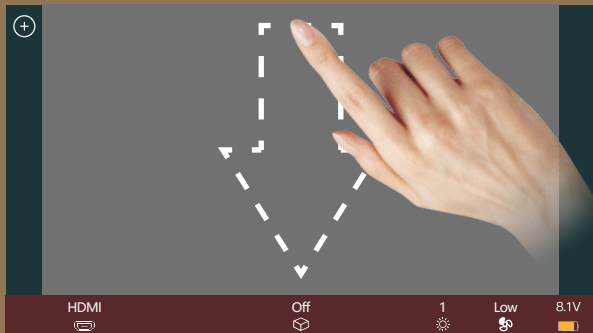

[Camera control settings page switch]

Swipe down on any page can be adjusted to the camera control settings page;

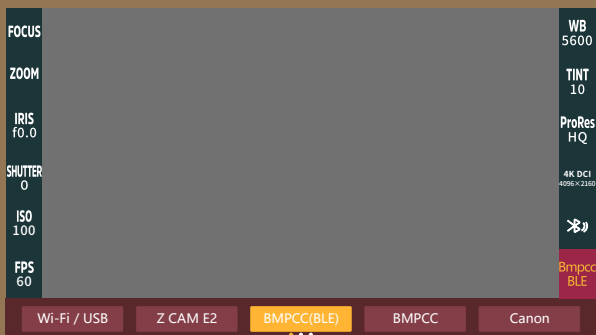

(the camera control settings page)

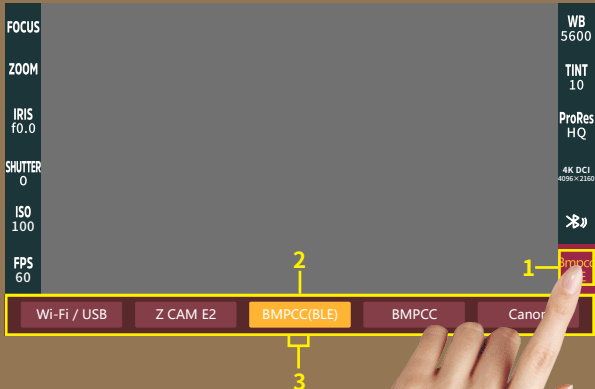





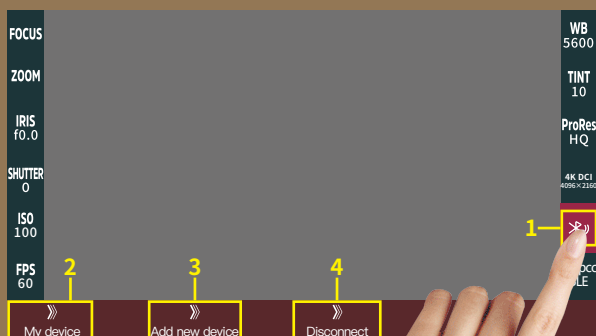

[Camera Model Setting]

1. Click “**Bmpcc**”
BLE” ;
2. Camera model options: Wi-Fi/USB、Z CAM E2、
BMPCC4K(BLE)、BMPCC、Canon、
Canon (LANC)、Sony(MUTI)、
Sony(LANC)、Panasonic、Panasonic(USB) ;
Currently selected “**BMPCC4K(BLE)**” ;
3. Display the number of the page of camera brands ,Swipe left
and right in the bottom information area to switch pages ;



[Bluetooth Connection]

1. Click “”;
2. Select “”, Make bluetooth connection (Successfully connected bluetooth record);
3. Select “”, turn on the BMPCC4K/6K Bluetooth function and record the passcode (picture 1), enter the passcode on the monitor (Picture 2 and 3), click “”, After successful connection, The Bluetooth icon will be displayed in yellow “”;
4. Select “” to disconnect the Bluetooth connection;



(picture 1)

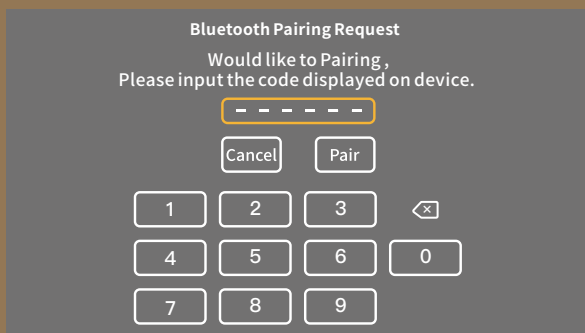

(picture 2)

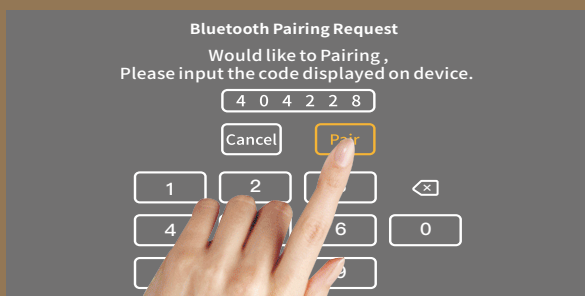

(picture 3)

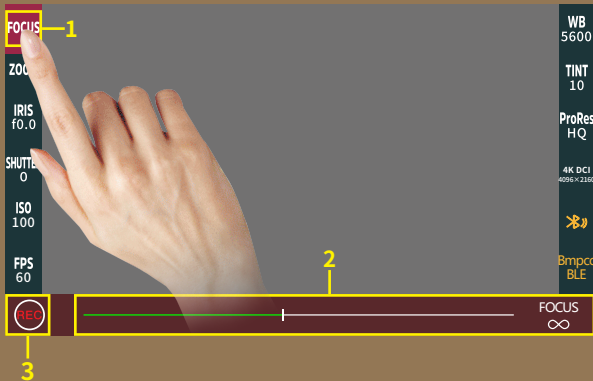

[FOCUS Setting]

1. Click " FOCUS " ;
2. Adjust the parameter on the progress bar ;
3. Record ;

[Wi-Fi Connection]

1. On the KOMODO camera, go to the Main menu, find Communication, select Wi-Fi, and then enable "Ad-Hoc".

*Ad-Hoc: KOMODO will create its own network, and the name and password will default to the PIN code of the camera. Make sure that the SSID setting starts with "KOMODO" or "komodo" and the frequency band is "2.4GHz".

2. Select the "Wi-Fi / USB" camera mode on the monitor, Click the "📷" to open the "🔴" Wi-Fi.



3. Select the "» My device" to connect to the Wi-Fi (Connected Wi-Fi).



4. Select "» Add new device", select the Wi-Fi name on the monitor, And enter the password. Tap " ", the Wi-Fi icon will be displayed as "📶" after successful connection.



5. Select "» Disconnect" to disconnect the Wi-Fi.

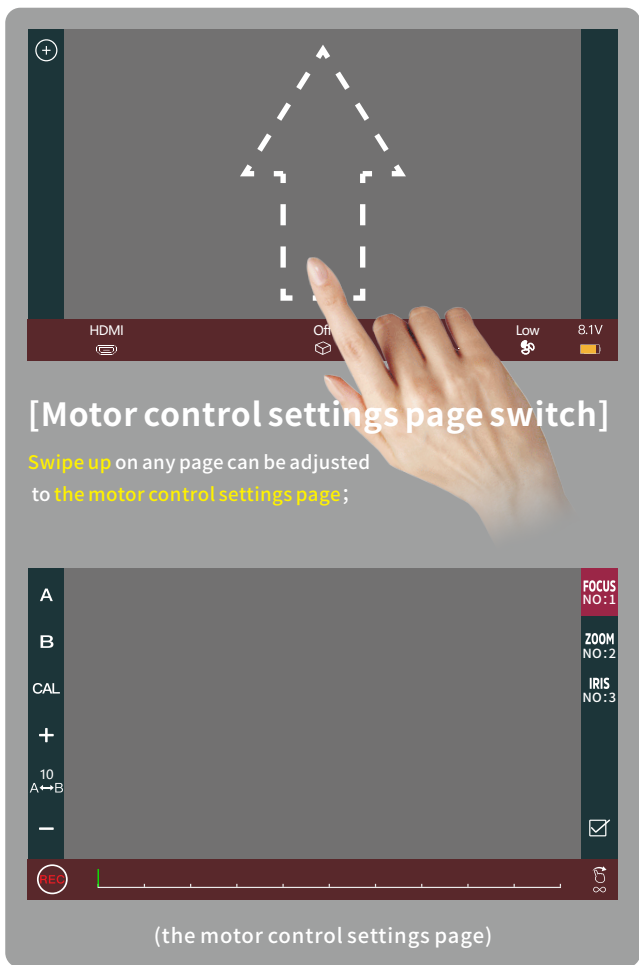

(the motor control settings page)

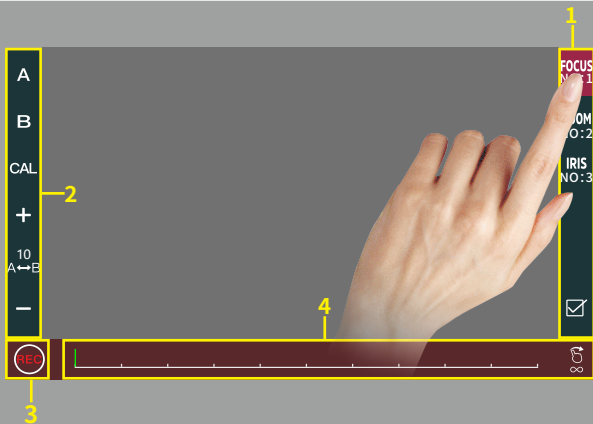

[Motor Setting]

1. Click to select channel options “ **FOCUS** NO:1 ”;
2. Select the channel option to set the channel parameters;
3. Record;
4. Adjust the motor stroke;